

# Wizards of N10G

## Streetblaster Series Wet Nitrous Kits Owner's Manual

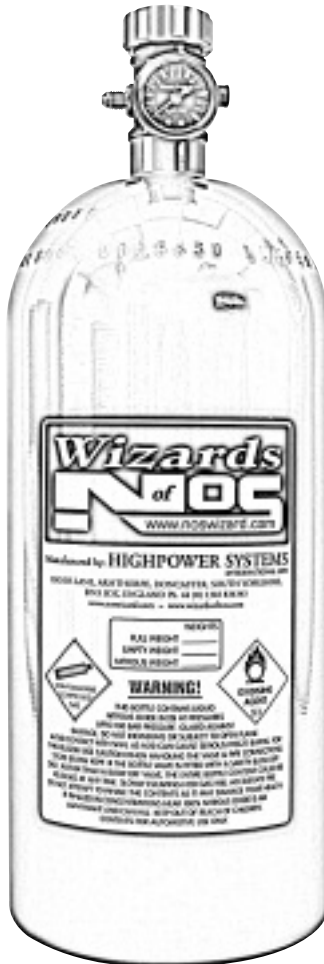

# Table of Contents

List of products.....	1
Nitrous Do's & Dont's.....	2
Nitrous Cylinder Installation.....	3
Nitrous Supply Pipe Installation.....	4
Pulsoid Installation / Jetting.....	5
Line Fitting.....	6
Fuel Supply and Plumbing Instructions.....	7-8
Injector Installation.....	9
Micro Switch and TP1 Installation.....	10-11
Fitting Summary/Test Procedure.....	12

## Tools Required

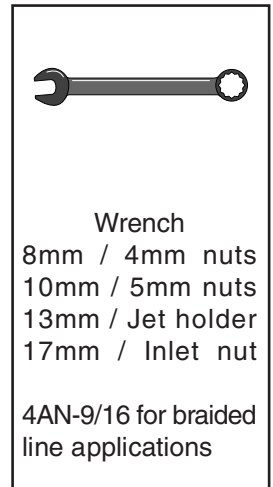
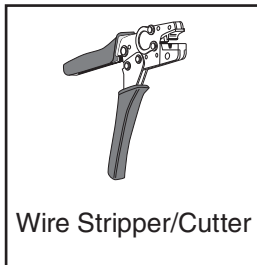
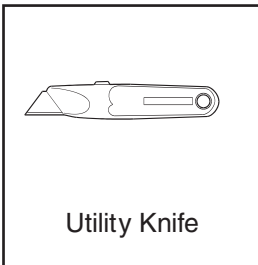
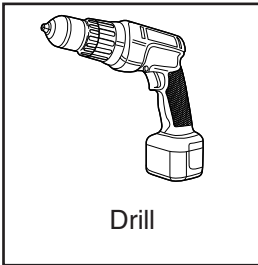

100i

100i2

100i4

100i6

100i8



- 5lb bottle
- 11lb bottle



- Bottle bracket

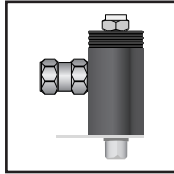

- N2O Solenoid Blue - Silver
- Fuel Solenoid Red - Black

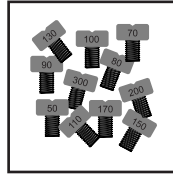

- Jets
- N2O \_\_\_\_\_
- Fuel \_\_\_\_\_

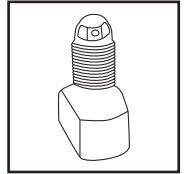

- Cross-fire injector /'s

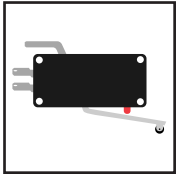

- Micro Switch w/ bracket

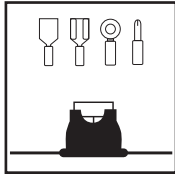

- Wiring 3m
- Connectors
- Fuse holder
- 20 amp fuse



- 4mm (red)
- 4mm (blue)
- 5mm (red)
- 5mm (blue)

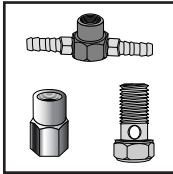

- Fuel Fitting
- Fuel barb
- Schrader
- Banjo bolt

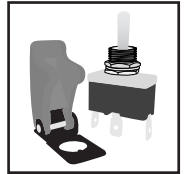

- Arming switch w/ flip cover

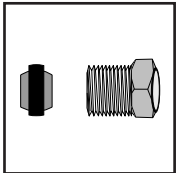

- 4mm nuts/olives

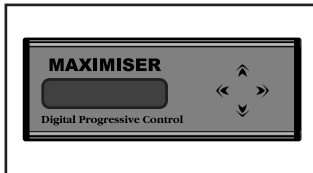

- Maximiser



- Minimax



- 4 x dizzy block

- 5mm nuts/olives



- Sticker

- 6 x dizzy block

### Optional Accessories

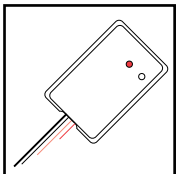

- TP1 Unit

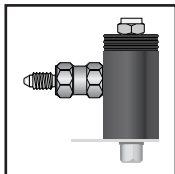

- Purge kit Blue - Silver

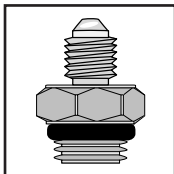

- 7/16 UNF (4AN) male adapter

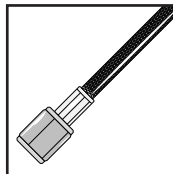

- SS line \_\_\_\_\_ ft.

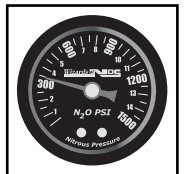

- N2O gauge

Misc. \_\_\_\_\_

# NITROUS DO'S & DONT'S

Items **without** an \* should be carried out before using the system. Items marked **with** an \* may apply to power increases above 25 bhp and items marked **with** a \*\* should apply to increases above 50 bhp. These are just general guidelines to follow and can vary per application.

- Do** replace the existing distributor cap and rotor arm if applicable.
- Do** have your fuel system tested to make sure wanted power can be supported.
- Do** replace the existing spark plugs with one grade colder (harder).\*
- Do** fit a set of quality plug wires (leads) if applicable.
- Do** fit a high capacity fuel pump.\*\*
- Do** have your engine compression checked with a leakage tester (not a compression gauge). 6% is just acceptable, but no cylinder should exceed a 10% leakage.
- Do** fit a high performance ignition coil and ignition system if applicable.\*\*
- Do** retard your ignition timing 2 degrees for every 50 bhp.\*\*
- Do** check torque settings of head bolts.
- Do** use only top quality oil. \*\*
- Do** use high octane fuel (petrol) and even higher octane for power increases over 50%.\*\*
- Do** purge the nitrous system at night or when the vehicle is left unattended.
- Do** fit an Ignition Delay Unit (IDU) or an ignition kill switch to prevent the possibility of backfires that may be caused when starting an engine with a static nitrous charge in the cylinders.
  
- Do not** operate the nitrous system without the engine running at a suitable rpm in an appropriate gear.
- Do not** start the engine if you suspect the nitrous system has been activated while the engine was not running. Purge the nitrous from the engine by removing the plug caps and cranking the engine over, or fit an Ignition Delay Unit (see proper section in manual for more information).
- Do not** use the nitrous system when the engine is off load other than for brief testing during a static test.
- Do not** leave the nitrous bottle valve open while the engine is not running.
- Do not** use any components other than those supplied with the system. Each component is an integral part of the system and incorrectly matched or unsuitable components may cause engine failure at worst, or may not produce the best results at least.

NOTE: Remember that any weakness in the original design of the engine and transmission will be brought nearer to it's limit when large amounts of nitrous are used. Therefore it is advisable to strengthen any such known weak components before too much power is added. It would be impossible to give details for every vehicle as to exactly what mods will need to be carried out and at what % increase. However we can say one thing for certain: the more power that you want, the greater the need to make modifications. The areas that may need modifications are: fuel system, ignition components(as listed above), head gasket, pistons, connecting rods, and clutch.



Failure to follow advice can result in poor results/performance, or engine damage.

# Nitrous Cylinder Installation and Mounting

The nitrous cylinder must be mounted exactly as shown (Fig.1). In this position **liquid** nitrous oxide will be delivered, which is essential for the system to work properly. The brackets supplied will provide a secure mounting with quick release for ease of refilling.

Position the bottle brackets to ensure that the valve end of the bottle is **higher** than the base end, with the outlet pipe connection pointing towards the floor (no other way). **Please contact us if you are unable to mount the cylinder as shown for vehicle specific advice.**

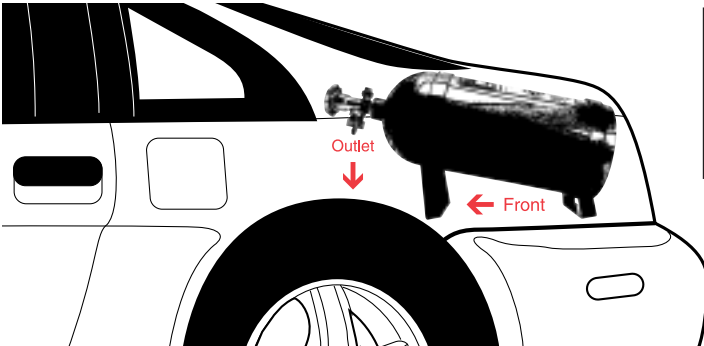

**Fig. 1**

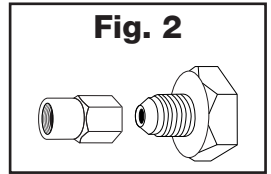

Bottle nut adapter for valves other than ours needing to connect our nylon pipe.

## **WARNING**

**The cylinder valve should not be opened unless the outlet is aimed into open space, or connected to the system.** When the valve is opened nitrous is discharged at a high pressure (approximately 800-1,200 psi @ - 129 degrees), at which this temperature can cause a painful freeze burn if it makes contact with the skin.

The Max Flow valve is equipped with an SPRV (Safety Pressure Relief Valve). The SPRV replaces the common **blow off disc** on other valves and works by opening and bleeding off excess **gaseous** pressure. When the set pressure is reached the valve will close again. This cycle will always be repeated automatically.

**Note: Wasted gaseous nitrous is very minimal. Please contact if adjustment is required from roughly 1,000psi factory setting.**

# Supply Line Routing

**5mm Nylon Line:** The vital route of the nylon nitrous supply line for **best** performance is shown in (Fig. 3), where the pipe runs through the inside of the car alongside the wiring loom and into the skuttle, between the windshield (screen) and engine bay **(A)**, or the front inner fender (wing) or similarly cool area **(B)**.

**SS Braided Line:** If you have chosen the optional braided line then be sure to route in as cool as possible exterior location. You will most likely have to drill a hole in your boot(trunk), truck bed, or hatchback area floor to pull the line through to underneath the vehicle and run up to the engine bay. If you are unable for any reason to route the pipe as shown and explained, **please contact us for advice.**

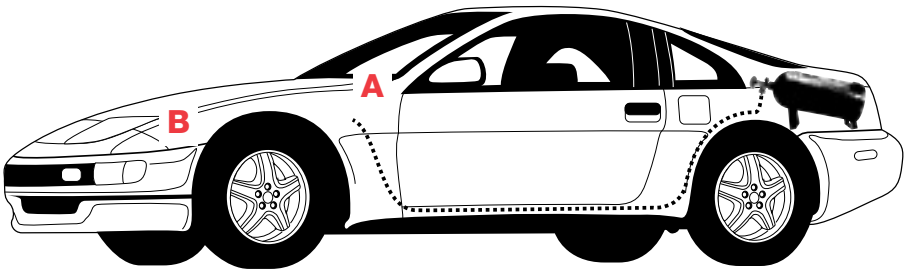

Fig. 3

## **WARNING**

**Do not** kink the nylon pipe by bending it too tightly, as this will weaken the pipe and could result in bursting when the pipe is filled with **high pressure**. **Do not** allow the nylon nitrous supply line to make 'direct' contact with **hot** objects as this will weaken the pipe and could result in bursting when under high pressure. **Always** protect the nylon supply line from or in areas of extreme heat(eg; engine bay, exhaust).

**Always** try to run the supply pipe in as cool an area as possible and keeping the routing path away from extremely hot parts. This will only boil the nitrous sooner, which results in poor performance or loss of overall performance from overfueling. The 5mm (blue) nitrous supply line is rated at 1500 psi working pressure and can burst if pressures near or exceed this. We don't advise pressurising the line or keeping the line pressurised if your gauge reads levels above 1200psi. Take measures to cool the bottle down to normal usable pressures (1100psi or less) as this will only aid in your safety, reliability of nitrous supply line, and performance as you now have denser liquid nitrous that contains more oxygen to burn more fuel.

# Nylon & Braided Line Fitting's

Run the enclosed 5mm blue nylon pipe from the nitrous cylinder to the nitrous (blue) pulsoid inlet (Fig. 4). Cut the pipe to length using a sharp utility knife or supplied cutter. (**Do not** use wire snips, pliers, etc. as these will deform the pipe end and make it almost impossible to fit the nut and olive). Slide the nut and olive onto the pipe ends as shown below (Fig. 5). Insert the pipe ends into the fittings (bottle, pulsoid, etc.). Tighten the nut to retain and seal the pipe (but without excessive force) as this will crush (neck) the pipe and restrict the flow. Make sure to hold the nylon pipe securely, so it doesn't back out while tightening the nut.

To check that the pipe is totally sealed, briefly turn on the nitrous cylinder valve and inspect for leaks with soapy water at the connections. If a leak is detected, tighten up the nut (whilst avoiding contact with any escaping gas particles) until the leak is stopped. When you are satisfied that the system is leak proof, release the pressure in the system by using an optional purge if installed or loosening the fitting at the bottle nut.

**IMPORTANT: When tightening the fittings to secure pipes, we strongly advise the use of the correct size spanners otherwise damage may occur and the fittings may fail to do their job.**

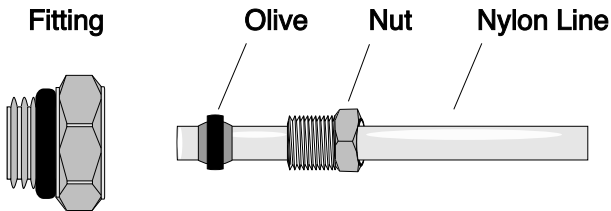

**Fig. 5**

## Braided Line Applications

**NOTE: This fitting does not require sealant on threads. Use an -AN wrench or equivalent wrench of proper size, so fitting end does not get damaged.**

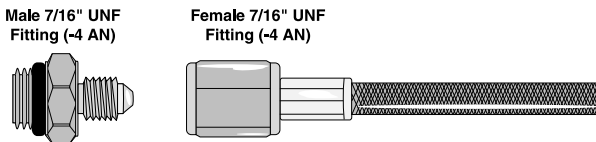

**Fig. 6**

# Pulsoid Installation

The pulsoids must be mounted in as cool a location possible, and close to the injector (**if possible the pipe between the pulsoid and the injector should be kept under 12" for optimum performance**). The pulsoids must also be easily accessible for jet changing, as the metering jets are located in the outlet (Fig.4). If possible **never** mount the Pulsoids at the back of the engine, on the firewall (bulk head), or rear inner fender (wings) as these are the hottest parts of the engine bay and can start or increase the vaporisation process of nitrous much earlier. Examples of suitable pulsoid locations in the order of preference; **1)** Skuttle between windshield (screen) and engine bay, **2)** Front grille, **3)** Front inner fender (wing). **Never remove bottom stud of pulsoid or use loctite on stud.**

## - N O T E -

The nitrous filter is a white element located inside the Nitrous solenoid inlet nut. Use two 17mm spanners to separate the nut in two pieces and access. If dirty, replace for consistent and optimal flow.

The fuel solenoid requires no filter as the factory fuel filter is adequate.

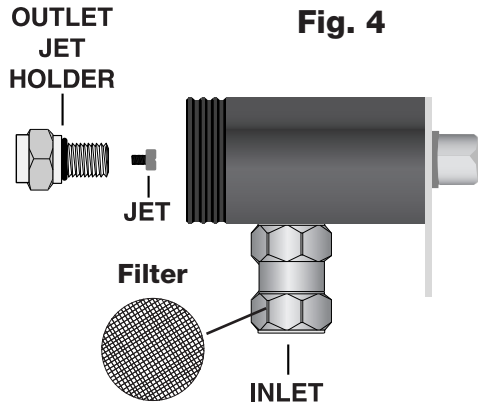

## Jetting (fuel injected vehicles ONLY)

- 1) The 'theoretical' power rating is half the nitrous jet number (e.g. 200 = 100bhp).
- 3) The fuel jet is initially matched to the nitrous jet at a ratio of 2:1 to produce a very safe, rich A/F ratio. Example: a nitrous jet marked 200 would need a fuel jet of 100 and would have a theoretical power rating of 100 bhp (on n/a cars this may result in less than 100hp whilst a t/c or s/c motor may see more than 100hp).
- 5) After initial tests have been carried out and reported back to us, any adjustments to the nitrous:fuel mixture ratio can be made by appropriate fuel jet changes.
- 6) Once the 'optimum' mixture ratio has been determined, this ratio of jet sizes should be maintained as you move up the power ladder.

For vehicles other than fuel injected, the initial ratio is 1:1

The ratios listed are approximations and fine tuning for individual vehicles may be required

# Fuel Supply (Take Off) Instructions & Plumbing

Using one of the methods mentioned use the red nylon line supplied as a fuel feed line. **Method 1)** Our **pressure port adapter** provides a simple connection for some cars. Remove the blanking cap, then carefully press the valve stem to depressurise the system, (catch the leaking fuel with a rag then dispose of it properly). Remove the valve core using the tool provided. This is vital as failure to do so may result in engine failure. Mount the adapter supplied with the kit onto the valve body (fit nylon washer between adapter and square edge style ports for proper sealing or if other sealing issues arise). **Method 2)** Our **banjo bolt** replaces the existing one fitted to the fuel filter (or the fuel rail). Slightly slacken the existing banjo bolt to let the fuel pressure leak away, (catch leaking fuel with a rag and then dispose of the rag carefully). **Method 3)** Our **T barb** is designed to fit into a wide range of fuel delivery pipe sizes, just cut the fuel pipe at a suitable point and fit with the securing clamps provided. Once the fuel adapter is fitted the next step is to cut a piece of the flexible red pipe and connect to the (red) fuel pulsoid (Refer to Fig. 5). **Please contact if braided is needed or preferred.**

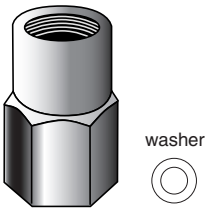

**Method 1) Schrader adapter**

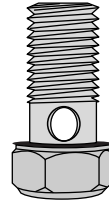

**Method 2) Banjo Bolt**

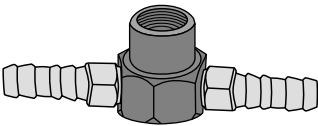

**Method 3) T Barb**

## **WARNING**

Be sure to check and secure all fuel fittings. Any amount of fuel leakage could cause a fire and possible damage to vehicle and person.

See next page (Fig. 7 & 8) for fuel fitting locations and installation.

**Fig. 7**

## Fuel Adapters

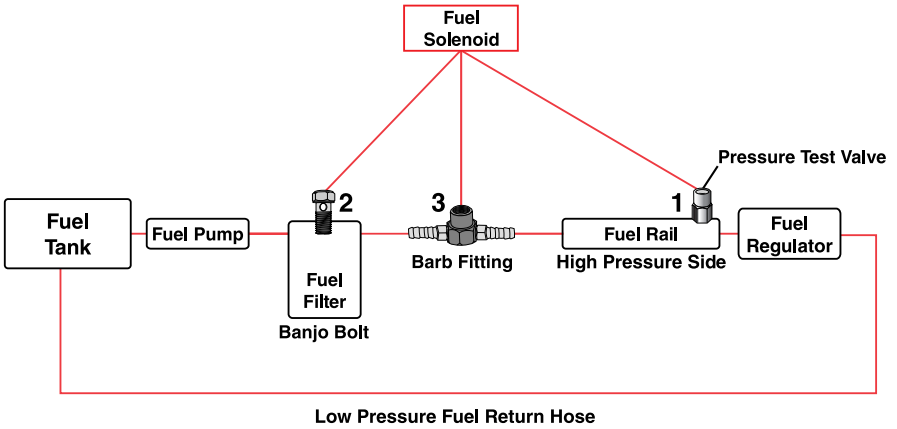

Please find the fuel source that applies to your application and follow directions from previous page. **Please contact us if unsure of proper or safe supply.**

**Fig. 8**

## Plumbing

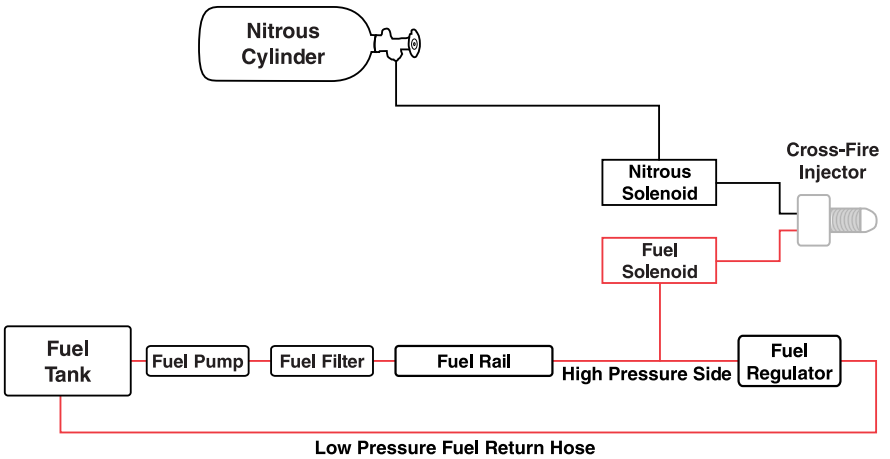

 **WARNING**

It's vital that the fuel adapter (take off) supplied with the kit is connected on the **high pressure** side of the fuel regulator. **Do not** connect to the low pressure **return** side of the regulator as this can result in engine failure.

# Cross Fire Injector Installation

Cross fire injectors are usually fitted to injected cars nearest to the throttle body or after the throttle body in the intake tube, plenum, etc. This will ensure proper delivery without risk of fuel drop-out as the flow path is kept short and free of upward travel.

Fit the injector into the rubber, metal, or plastic intake tube by punching or drilling an 8mm hole at a suitable location as near as possible to the throttle body. Secure the injector in place by screwing on the retainer from inside the intake tube/hose (Fig. 9). Heavy wall metal tubes may not need the retainer and can just be held in place by resistance once tightened down properly. **(A 10mmx1mm tap is needed for tap applications)**. Two spacers are provided to suite various applications. The injector only needs to be screwed in and lightly nipped up using a mild loctite sealer on the injector body threads **only**.

Ensure the outlet ports protrude beyond the retainer and/or clear any part for proper flow and performance (Fig. 9). **Please contact if having questions or trouble with above instructions.**

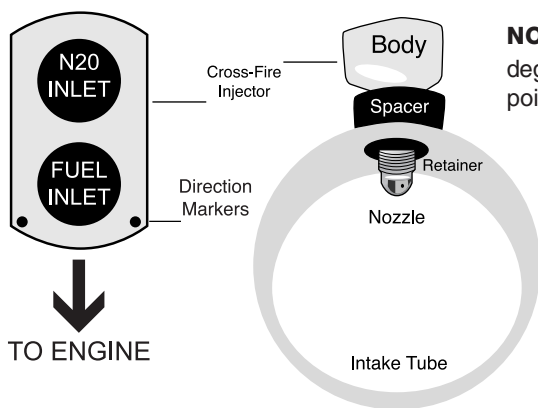

**NOTE:** Have injector angled about 15 degrees off center for vortex effect. Don't point straight down intake tube.

**Fig. 9**

 **WARNING**

**Disregarding these instructions could result in poor performance and/or engine damage.**

# Throttle Micro Switch Installation

The micro switch should be mounted to the throttle body, foot pedal, etc. where it can be activated at wide open throttle after modifying the universal mounting bracket as required to suit your car. Once fitted it is **essential** to check the operation in the following manner.

1. Have the **driver** sit in the drivers seat as **normal**.
2. Have the **driver** slowly press down **fully** on the throttle pedal, whilst an assistant watches the movement of the throttle mechanism in the engine bay.
3. Check that the throttle mechanism **fully** operates the micro switch.

**IMPORTANT:** Never rely on setting up the switch by hand operating the throttle mechanism, as this may not duplicate actual pedal movement.

**Fig. 10**

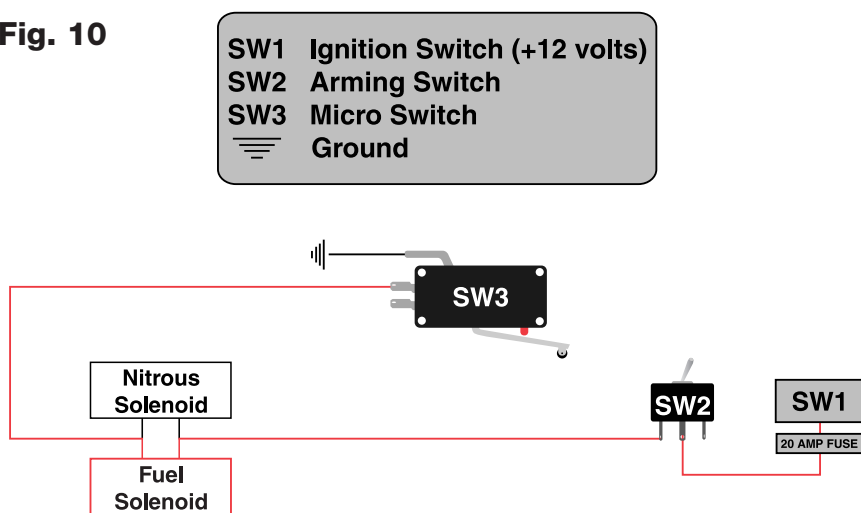

## **WARNING**

Never use a low amp micro switch. If replaced a 12-15 amp switch must be used for reliable use. Also use a 15-20 amp activation switch.

**NOTE:** If using multiple solenoids, connect in parallel the same way as shown above for a single pair of solenoids. Example: A wire from each solenoid will connect together to a power source. Then the other wire from each solenoid will connect together to a ground. A 30-40 amp relay must be added for multiple sets of solenoids when not using a progressive controller.

## - OPTIONAL - TPS(TP1) Switch Installation

**1.** Using a **digital** volt meter and with the ignition switched **on**, determine which wire on the throttle position sensor gives either a 0 to 5 volt reading (or the reverse on some applications) as the throttle is activated. When you have determined the right wire on your TPS sensor, connect the **white** wire from the TP1 unit to it by stripping the wire and making a soldered connection.

**2.** For direct feed from battery: Wire the remaining wires as shown (Fig.11), but leave the pink (pink wire will activate the solenoids) and red wires disconnected.

**a)** Turn the ignition on. **b)** Press and hold the TPS set button and connect the red TPS wire to power (12 V). Release the set button and the led should illuminate for 2 seconds. **c)** Open the throttle using the pedal to the position that you want the Nitrous System to activate (between 80 and 90% of full throttle) and then briefly press the set button again. The LED should illuminate for 2 seconds again and then switch off, which indicates that the unit is ready for use. Opening the throttle to WOT should now cause the LED to illuminate. **d)** Now wire remaining wires with power switched off.

**3.** For connection to 12V ignition: Wire the remaining wires as shown (Fig.11), but leave the pink (pink wire will activate the solenoids) disconnected. **a)** Press and hold down the set button with the ignition turned off. **b)** Turn on the ignition switch to IGN only (**not Start**) and release the set button. The LED should illuminate for 2 seconds after you release the set button. **c)** Open the throttle using the pedal to the position that you want the Nitrous System to activate (between 80 and 90% of full throttle) and then briefly press the set button again. The LED should illuminate for 2 seconds again and then switch off, which indicates that the unit is ready for use. Opening the throttle to WOT should now cause the LED to illuminate. **d)** Now connect the **pink** wire as shown (Fig. 11) after the unit has been set.

**4.** Operating the pedal/throttle past the **set** position should activate the relay and pulsoids, at this time the LED should light up.

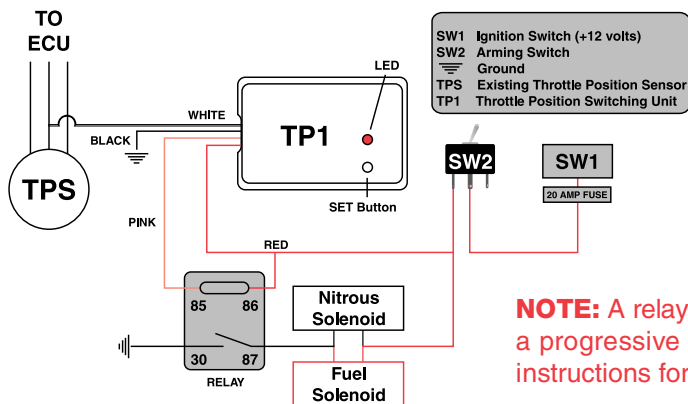

**Fig. 11**

**NOTE:** A relay is not needed if using a progressive unit. Use progressive instructions for wiring diagram.

## Fitting in Brief

1. Mount the nitrous cylinder as shown in (Fig.1).
2. Run the supply pipe as shown in (Fig. 3).
3. Mount the pulsoids (blue or polished nitrous, red or black fuel) in as cool of a location as possible and nearest to the injector. (Fig. 4).
4. Connect into the existing fuel supply line (**only** on the **delivery, not return** side of the system), using the proper adapter per application (Fig. 7).
5. Install the cross-fire injector or injectors in the induction system (Fig. 9).
6. Run the flexible red (fuel) and blue (nitrous) pipes from the solenoid outlets to the injectors and connect using the nuts and olives supplied (Fig. 4 & 5).
7. Connect the proper activation switch (TP1 or micro switch, Fig. 10 & 11) and connect all other electrical hardware.

## Test Procedure (Static Test)

1. Disconnect the outlet pipes from the injector's and aim the N2O to atmosphere and the fuel pipe into a bottle. Hold both pipes securely and activate the system briefly, monitoring the results at the open pipe ends. Fuel and N2O liquid should be seen flowing from the pipes as the system is activated, and should stop flowing when the system is switched off. **Important:** Do not use the system if fuel does not flow when the system is activated. **Phone for assistance.**
2. Connect the nylon pipes back to the injector/'s.
3. Start the engine and run up to normal temperature, hold the revs at approx. 1/3 of max. rpm (e.g. max. rpm limit 6,000 test rpm 2,000) and briefly activate the system whilst monitoring the engines response, and the exhaust gases. **a)** Nearest to redline indicates optimal power but running near the lean side so be confident in your engine combination and tune. **b)** Revving past redline indicates to lean, so increase the fuel jet. **c)** To low of an rpm rise indicates to rich of a mixture so decrease the fuel jet. **A nice and safe mixture would be an engine rise 500-1000 rpm below redline**
4. Engine rpm should rise (as if you had operated the throttle) and then fall back to normal as you release the switch. If the engine sounds in any way different to the way it sounds when you rev up the engine normally, cease testing.
5. If all goes as it should, then you can take the vehicle on the road and carry out the next tests; **a)** Accelerate hard from say 30 mph up to 70 mph. Slow to a stop and then shut off the engine, stop the vehicle and remove the spark plugs for inspection. **b)** Repeat the test using nitrous this time and compare the plug colour with the colour without nitrous. You should feel a stronger acceleration and the plugs should be the same or slightly darker colour. If you hear any noises other than a louder exhaust note or you feel anything other than a smooth surge of power, cease the test

**Please contact our technicians if having any questions, troubles, or doubts.**



Make/Model - Engine	Nitrous Jet	Fuel Jet	Pressure

## Lifetime Warranty

Highpower products are covered by a Lifetime warranty against any defects for the lifetime of the original purchaser. This warranty does not cover any damage done by modifying or tampering of the original product outside of a Highpower representative. If any part becomes faulty, please contact a Highpower office with proof of purchase for an exchange or warranty coverage.

### Highpower Systems International Ltd.

Rands Lane, Armthorpe Doncaster  
South Yorkshire, England  
DN3 3ER, UK.  
44 (0) 01302 834343  
[www.noswizard.com](http://www.noswizard.com)